

φ32用 チーズ

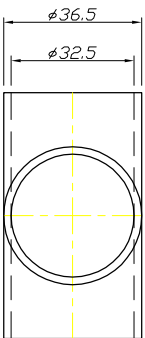

φ25用 チーズ

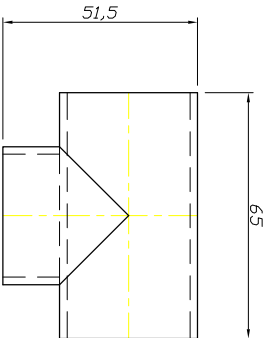
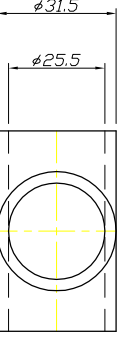
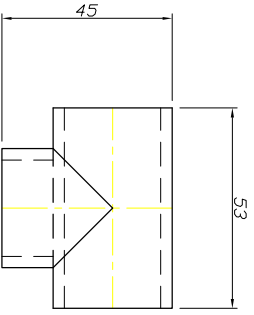

φ32用 エルボソケット

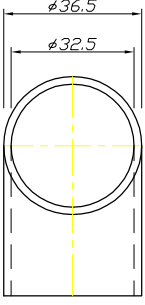
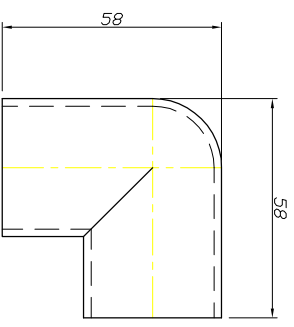

φ25用 エルボソケット

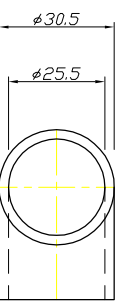
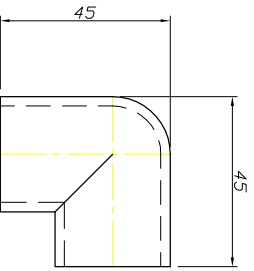

φ32用 ソケット

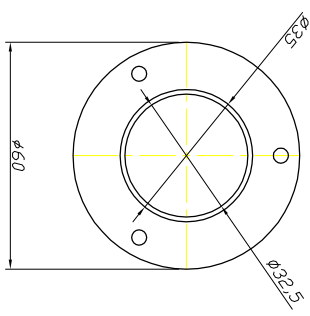
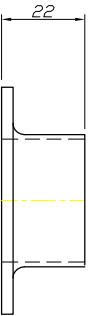

φ25用 ソケット

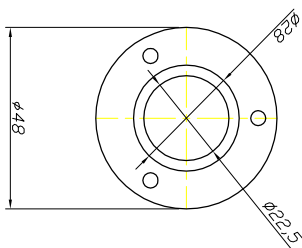
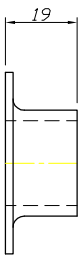

φ32用 二重ソケット

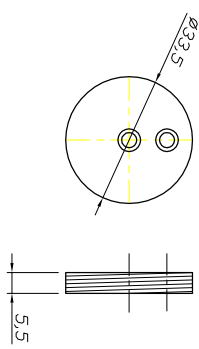
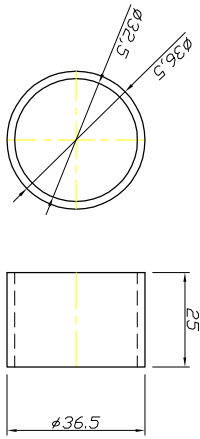

φ25用 二重ソケット

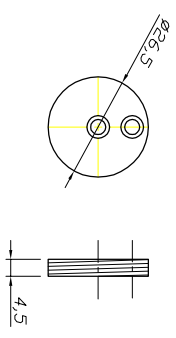
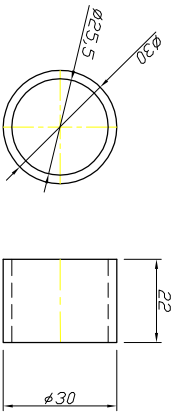

名称	手摺、パイプ 各詳細図面		
材質			
日付	H23.5.14	仕上	
図番	PR-K-002	尺度	
大阪総合内装株式会社			